



ULTRA LOW DROP VOLTAGE REGULATORS WITH INHIBIT LOW ESR OUTPUT CAPACITORS COMPATIBLE

- STABLE WITH LOW ESR CERAMIC CAPACITORS
- ULTRA LOW DROPOUT VOLTAGE (0.17V TYP. AT 100mA LOAD, 7mV TYP. AT 1mA LOAD)
- VERY LOW QUIESCENT CURRENT (80 μ A TYP. AT NO LOAD IN ON MODE; MAX 1 μ A IN OFF MODE)
- GUARANTEED OUTPUT CURRENT UP TO 100mA
- LOGIC-CONTROLLED ELECTRONIC SHUTDOWN
- OUTPUT VOLTAGE OF 1.5; 1.8; 2.5; 2.85; 3.0; 3.2; 3.3; 3.6; 3.8; 4.0; 4.7; 4.85; 5.0V
- INTERNAL CURRENT AND THERMAL LIMIT
- $\pm 0.75\%$ TOLERANCE OUTPUT VOLTAGE AVAILABLE (A VERSION)
- OUTPUT LOW NOISE VOLTAGE 160 μ VRMS
- TEMPERATURE RANGE: -40 TO 125 $^{\circ}$ C
- SMALLEST PACKAGE SOT23-5L AND SOT-89
- FAST DYNAMIC RESPONSE TO LINE AND LOAD CHANGES

DESCRIPTION

The LD2981 series are 100mA fixed-output voltage regulator. The low drop-voltage and the

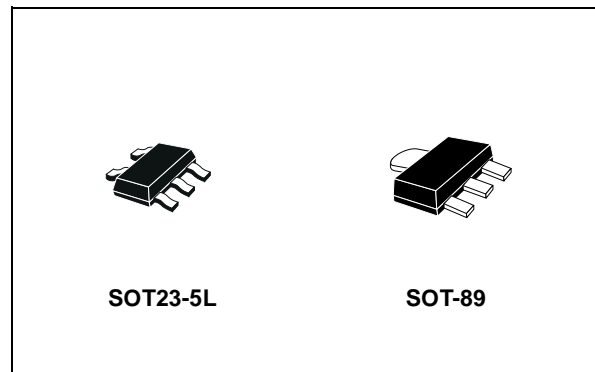

ultra low quiescent current make them suitable for low noise, low power applications and in battery powered systems.

The quiescent current in sleep mode is less than 1 μ A when INHIBIT pin is pulled low. Shutdown Logic Control function is available on pin n.3 (TTL compatible). This means that when the device is used as local regulator, it is possible to put a part of the board in standby, decreasing the total power consumption. The LD2981 is designed to work with low ESR ceramic capacitor. Typical applications are in cellular phone, palmtop/laptop computer, personal digital assistant (PDA), personal stereo, camcorder and camera.

SCHEMATIC DIAGRAM

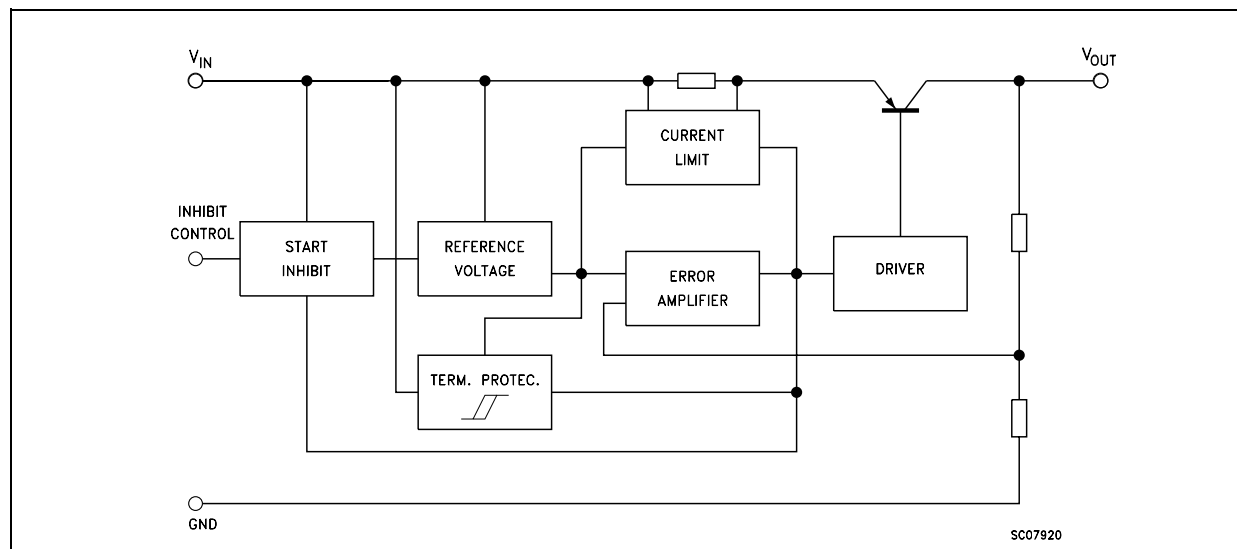

LD2981 SERIES

ABSOLUTE MAXIMUM RATINGS

Symbol	Parameter	Value	Unit
V_I	DC Input Voltage	-0.3 to 16	V
V_{INH}	INHIBIT Input Voltage	-0.3 to 16	V
I_O	Output Current	Internally limited	
P_D	Power Dissipation	Internally limited	
T_{STG}	Storage Temperature Range	-55 to 150	°C
T_{OP}	Operating Junction Temperature Range	-40 to 125	°C

Absolute Maximum Ratings are those values beyond which damage to the device may occur. Functional operation under these condition is not implied.

THERMAL DATA

Symbol	Parameter	SOT23-5L	SOT-89	Unit
$R_{thj-case}$	Thermal Resistance Junction-case	81	15	°C/W
$R_{thj-amb}$	Thermal Resistance Junction-ambient	255	110	°C/W

CONNECTION DIAGRAM (top view)

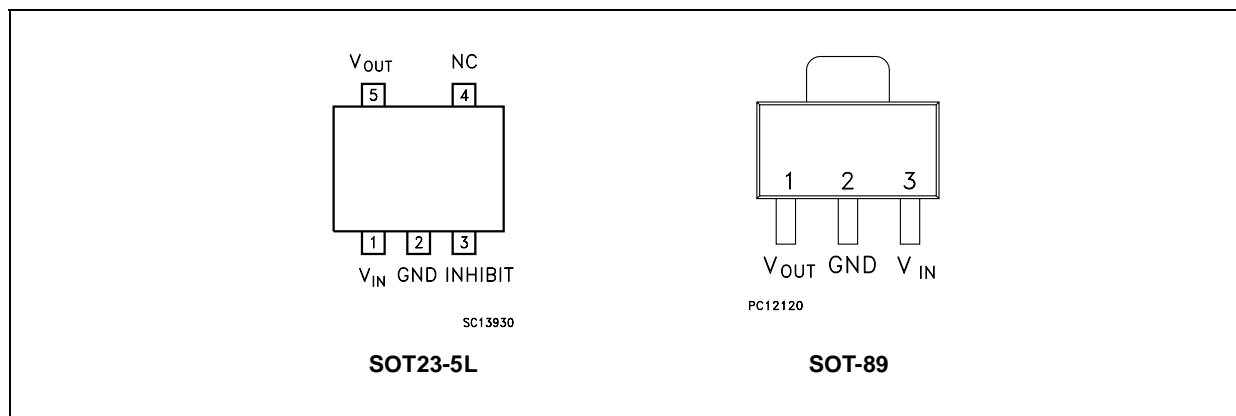

PIN DESCRIPTION

Pin N° SOT23-5L	Pin N° SOT-89	Symbol	Name and Function
1	3	V_{IN}	Input Port
2	2	GND	Ground Pin
3		INHIBIT	Control switch ON/OFF. Inhibit is not internally pulled-up; it cannot be left floating. Disable the device when connected to GND or to a positive voltage less than 0.18V
4		NC	Not Connected
5	1	V_{OUT}	Output Port

ORDERING CODES

AB VERSION		C VERSION		OUTPUT VOLTAGES
SOT23-5L	SOT-89	SOT23-5L	SOT-89	
		LD2981CM15TR	LD2981CU15TR	1.5 V
		LD2981CM18TR	LD2981CU18TR	1.8 V
LD2981ABM25TR	LD2981ABU25TR	LD2981CM25TR	LD2981CU25TR	2.5 V
LD2981ABM28TR	LD2981ABU28TR	LD2981CM28TR	LD2981CU28TR	2.85 V
LD2981ABM30TR	LD2981ABU30TR	LD2981CM30TR	LD2981CU30TR	3.0 V
LD2981ABM32TR	LD2981ABU32TR	LD2981CM32TR	LD2981CU32TR	3.2 V
LD2981ABM33TR	LD2981ABU33TR	LD2981CM33TR	LD2981CU33TR	3.3 V
LD2981ABM36TR	LD2981ABU36TR	LD2981CM36TR	LD2981CU36TR	3.6 V
LD2981ABM38TR	LD2981ABU38TR	LD2981CM38TR	LD2981CU38TR	3.8 V
LD2981ABM40TR	LD2981ABU40TR	LD2981CM40TR	LD2981CU40TR	4.0 V
LD2981ABM47TR	LD2981ABU47TR	LD2981CM47TR	LD2981CU47TR	4.7 V
LD2981ABM48TR	LD2981ABU48TR	LD2981CM48TR	LD2981CU48TR	4.85 V
LD2981ABM50TR	LD2981ABU50TR	LD2981CM50TR	LD2981CU50TR	5.0 V

TYPICAL APPLICATION CIRCUIT

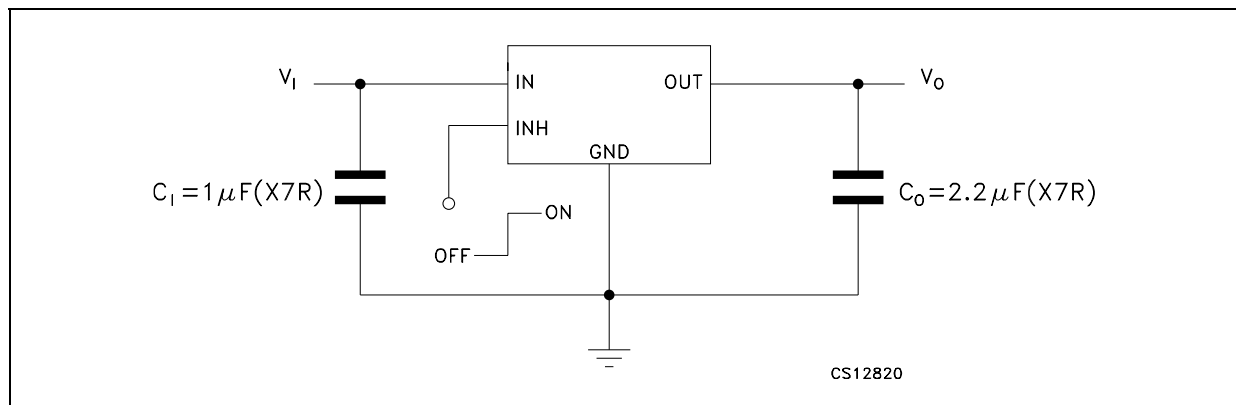

(*) Inhibit Pin is not internally pulled-up then it must not be left floating. Disable the device when connected to GND or to a positive voltage less than 0.18V.

LD2981 SERIES

ELECTRICAL CHARACTERISTICS FOR LD2981AB ($T_j = 25^\circ\text{C}$, $V_I = V_{O(\text{NOM})} + 1\text{V}$, $C_I = 1\mu\text{F(X7R)}$, $C_O = 2.2\mu\text{F(X7R)}$, $I_O = 1\text{mA}$, $V_{\text{INH}} = 2\text{V}$, unless otherwise specified)

Symbol	Parameter	Test Conditions	Min.	Typ.	Max.	Unit
V_{OP}	Operating Input Voltage		2.5		16	V
V_O	Output Voltage	$I_O = 1\text{ mA}$	2.481	2.5	2.518	V
		$I_O = 1\text{ to }100\text{ mA}$	2.475		2.525	
		$I_O = 1\text{ to }100\text{ mA}$ $T_J = -40\text{ to }125^\circ\text{C}$	2.437		2.562	
V_O	Output Voltage	$I_O = 1\text{ mA}$	2.828	2.85	2.872	V
		$I_O = 1\text{ to }100\text{ mA}$	2.822		2.878	
		$I_O = 1\text{ to }100\text{ mA}$ $T_J = -40\text{ to }125^\circ\text{C}$	2.779		2.921	
V_O	Output Voltage	$I_O = 1\text{ mA}$	2.977	3	3.023	V
		$I_O = 1\text{ to }100\text{ mA}$	2.970		3.030	
		$I_O = 1\text{ to }100\text{ mA}$ $T_J = -40\text{ to }125^\circ\text{C}$	2.925		3.075	
V_O	Output Voltage	$I_O = 1\text{ mA}$	3.176	3.2	3.224	V
		$I_O = 1\text{ to }100\text{ mA}$	3.168		3.232	
		$I_O = 1\text{ to }100\text{ mA}$ $T_J = -40\text{ to }125^\circ\text{C}$	3.12		3.28	
V_O	Output Voltage	$I_O = 1\text{ mA}$	3.275	3.3	3.325	V
		$I_O = 1\text{ to }100\text{ mA}$	3.267		3.333	
		$I_O = 1\text{ to }100\text{ mA}$ $T_J = -40\text{ to }125^\circ\text{C}$	3.217		3.383	
V_O	Output Voltage	$I_O = 1\text{ mA}$	3.573	3.6	3.627	V
		$I_O = 1\text{ to }100\text{ mA}$	3.564		3.636	
		$I_O = 1\text{ to }100\text{ mA}$ $T_J = -40\text{ to }125^\circ\text{C}$	3.510		3.690	
V_O	Output Voltage	$I_O = 1\text{ mA}$	3.771	3.8	3.829	V
		$I_O = 1\text{ to }100\text{ mA}$	3.762		3.838	
		$I_O = 1\text{ to }100\text{ mA}$ $T_J = -40\text{ to }125^\circ\text{C}$	3.705		3.895	
V_O	Output Voltage	$I_O = 1\text{ mA}$	3.97	4	4.03	V
		$I_O = 1\text{ to }100\text{ mA}$	3.96		4.04	
		$I_O = 1\text{ to }100\text{ mA}$ $T_J = -40\text{ to }125^\circ\text{C}$	3.9		4.1	
V_O	Output Voltage	$I_O = 1\text{ mA}$	4.664	4.7	4.735	V
		$I_O = 1\text{ to }100\text{ mA}$	4.653		4.747	
		$I_O = 1\text{ to }100\text{ mA}$ $T_J = -40\text{ to }125^\circ\text{C}$	4.582		4.817	
V_O	Output Voltage	$I_O = 1\text{ mA}$	4.813	4.85	4.887	V
		$I_O = 1\text{ to }100\text{ mA}$	4.801		4.899	
		$I_O = 1\text{ to }100\text{ mA}$ $T_J = -40\text{ to }125^\circ\text{C}$	4.729		4.971	
V_O	Output Voltage	$I_O = 1\text{ mA}$	4.962	5	5.038	V
		$I_O = 1\text{ to }100\text{ mA}$	4.950		5.050	
		$I_O = 1\text{ to }100\text{ mA}$ $T_J = -40\text{ to }125^\circ\text{C}$	4.875		5.125	
ΔV_O	Line Regulation	$V_{O(\text{NOM})} + 1 < V_{\text{IN}} < 16\text{ V}$ $I_O = 1\text{ mA}$		0.003	0.014	%V
		$T_J = -40\text{ to }125^\circ\text{C}$			0.032	

Symbol	Parameter	Test Conditions	Min.	Typ.	Max.	Unit
I_Q	Quiescent Current ON MODE	$I_O = 0$		80	100	μA
		$I_O = 0$ $T_J = -40$ to 125°C			150	
		$I_O = 1\text{ mA}$		100	150	
		$I_O = 1\text{ mA}$ $T_J = -40$ to 125°C			200	
		$I_O = 25\text{ mA}$		250	400	
		$I_O = 25\text{ mA}$ $T_J = -40$ to 125°C			800	
		$I_O = 100\text{ mA}$		1000	1300	
		$I_O = 100\text{ mA}$ $T_J = -40$ to 125°C			2600	
	OFF MODE	$V_{INH} < 0.3\text{ V}$			0.8	
	$V_{INH} < 0.15\text{ V}$ $T_J = -40$ to 125°C			2		
V_{DROP}	Dropout Voltage (NOTE 1)	$I_O = 0$		1	3	mV
		$I_O = 0$ $T_J = -40$ to 125°C			5	
		$I_O = 1\text{ mA}$		7	10	
		$I_O = 1\text{ mA}$ $T_J = -40$ to 125°C			15	
		$I_O = 25\text{ mA}$		70	100	
		$I_O = 25\text{ mA}$ $T_J = -40$ to 125°C			150	
		$I_O = 100\text{ mA}$		180	250	
		$I_O = 100\text{ mA}$ $T_J = -40$ to 125°C			375	
I_{SC}	Short Circuit Current	$R_L = 0$		150		mA
SVR	Supply Voltage Rejection	$C_O = 10\mu\text{F}$ $f = 1\text{ KHz}$		63		dB
V_{INH}	Inhibit Input Logic Low	LOW = Output OFF $T_J = -40$ to 125°C			0.18	V
V_{INL}	Inhibit Input Logic High	HIGH = Output ON $T_J = -40$ to 125°C	1.6			V
I_{INH}	Inhibit Input Current	$V_{INH} = 0\text{ V}$ $T_J = -40$ to 125°C		0	-1	μA
		$V_{INH} = 5\text{ V}$ $T_J = -40$ to 125°C		5	15	
e_N	Output Noise Voltage	$B_W = 300\text{ Hz}$ to 50 KHz $C_O = 10\mu\text{F}$		160		μV_{RMS}
T_{SHDN}	Thermal Shutdown			170		$^\circ\text{C}$

(NOTE 1): For $V_O < 2.5\text{V}$ dropout voltage can be calculated according to the minimum input voltage in full temperature range.

LD2981 SERIES

ELECTRICAL CHARACTERISTICS FOR LD2981C ($T_J = 25^\circ\text{C}$, $V_I = V_{O(\text{NOM})} + 1\text{V}$, $C_I = 1\mu\text{F}(X7R)$, $C_O = 2.2\mu\text{F}(X7R)$, $I_O = 1\text{mA}$, $V_{\text{INH}} = 2\text{V}$, unless otherwise specified)

Symbol	Parameter	Test Conditions	Min.	Typ.	Max.	Unit
V_{OP}	Operating Input Voltage		2.5		16	V
V_O	Output Voltage	$I_O = 1\text{ mA}$	1.478	1.5	1.522	V
		$I_O = 1\text{ to }100\text{ mA}$	1.470		1.530	
		$I_O = 1\text{ to }100\text{ mA}$ $T_J = -40\text{ to }125^\circ\text{C}$	1.445		1.555	
V_O	Output Voltage	$I_O = 1\text{ mA}$	1.777	1.8	1.822	V
		$I_O = 1\text{ to }100\text{ mA}$	1.764		1.836	
		$I_O = 1\text{ to }100\text{ mA}$ $T_J = -40\text{ to }125^\circ\text{C}$	1.737		1.863	
V_O	Output Voltage	$I_O = 1\text{ mA}$	2.468	2.5	2.531	V
		$I_O = 1\text{ to }100\text{ mA}$	2.45		2.55	
		$I_O = 1\text{ to }100\text{ mA}$ $T_J = -40\text{ to }125^\circ\text{C}$	2.412		2.587	
V_O	Output Voltage	$I_O = 1\text{ mA}$	2.814	2.85	2.885	V
		$I_O = 1\text{ to }100\text{ mA}$	2.793		2.907	
		$I_O = 1\text{ to }100\text{ mA}$ $T_J = -40\text{ to }125^\circ\text{C}$	2.75		2.949	
V_O	Output Voltage	$I_O = 1\text{ mA}$	2.962	3	3.037	V
		$I_O = 1\text{ to }100\text{ mA}$	2.94		3.06	
		$I_O = 1\text{ to }100\text{ mA}$ $T_J = -40\text{ to }125^\circ\text{C}$	2.895		3.105	
V_O	Output Voltage	$I_O = 1\text{ mA}$	3.16	3.2	3.24	V
		$I_O = 1\text{ to }100\text{ mA}$	3.136		3.264	
		$I_O = 1\text{ to }100\text{ mA}$ $T_J = -40\text{ to }125^\circ\text{C}$	3.088		3.312	
V_O	Output Voltage	$I_O = 1\text{ mA}$	3.258	3.3	3.341	V
		$I_O = 1\text{ to }100\text{ mA}$	3.234		3.366	
		$I_O = 1\text{ to }100\text{ mA}$ $T_J = -40\text{ to }125^\circ\text{C}$	3.184		3.415	
V_O	Output Voltage	$I_O = 1\text{ mA}$	3.555	3.6	3.645	V
		$I_O = 1\text{ to }100\text{ mA}$	3.528		3.672	
		$I_O = 1\text{ to }100\text{ mA}$ $T_J = -40\text{ to }125^\circ\text{C}$	3.474		3.726	
V_O	Output Voltage	$I_O = 1\text{ mA}$	3.752	3.8	3.847	V
		$I_O = 1\text{ to }100\text{ mA}$	3.724		3.876	
		$I_O = 1\text{ to }100\text{ mA}$ $T_J = -40\text{ to }125^\circ\text{C}$	3.667		3.933	
V_O	Output Voltage	$I_O = 1\text{ mA}$	3.95	4	4.05	V
		$I_O = 1\text{ to }100\text{ mA}$	3.92		4.08	
		$I_O = 1\text{ to }100\text{ mA}$ $T_J = -40\text{ to }125^\circ\text{C}$	3.86		4.14	
V_O	Output Voltage	$I_O = 1\text{ mA}$	4.641	4.7	4.758	V
		$I_O = 1\text{ to }100\text{ mA}$	4.606		4.794	
		$I_O = 1\text{ to }100\text{ mA}$ $T_J = -40\text{ to }125^\circ\text{C}$	4.535		4.864	
V_O	Output Voltage	$I_O = 1\text{ mA}$	4.789	4.85	4.91	V
		$I_O = 1\text{ to }100\text{ mA}$	4.753		4.947	
		$I_O = 1\text{ to }100\text{ mA}$ $T_J = -40\text{ to }125^\circ\text{C}$	4.68		5.019	
V_O	Output Voltage	$I_O = 1\text{ mA}$	4.937	5	5.062	V
		$I_O = 1\text{ to }100\text{ mA}$	4.9		5.1	
		$I_O = 1\text{ to }100\text{ mA}$ $T_J = -40\text{ to }125^\circ\text{C}$	4.825		5.175	

Symbol	Parameter	Test Conditions	Min.	Typ.	Max.	Unit
ΔV_O	Line Regulation	$V_{O(NOM)} + 1 < V_{IN} < 16\text{ V}$ $I_O = 1\text{ mA}$		0.003	0.014	%V
		$T_J = -40\text{ to }125^\circ\text{C}$			0.032	
I_Q	Quiescent Current ON MODE	$I_O = 0$		80	100	μA
		$I_O = 0$ $T_J = -40\text{ to }125^\circ\text{C}$			150	
		$I_O = 1\text{ mA}$		100	150	
		$I_O = 1\text{ mA}$ $T_J = -40\text{ to }125^\circ\text{C}$			200	
		$I_O = 25\text{ mA}$		250	400	
		$I_O = 25\text{ mA}$ $T_J = -40\text{ to }125^\circ\text{C}$			800	
		$I_O = 100\text{ mA}$		1000	1300	
		$I_O = 100\text{ mA}$ $T_J = -40\text{ to }125^\circ\text{C}$			2600	
	OFF MODE	$V_{INH} < 0.3\text{ V}$				0.8
		$V_{INH} < 0.15\text{ V}$ $T_J = -40\text{ to }125^\circ\text{C}$				2
V_{DROPO}	Dropout Voltage (NOTE 1)	$I_O = 0$		1	3	mV
		$I_O = 0$ $T_J = -40\text{ to }125^\circ\text{C}$			5	
		$I_O = 1\text{ mA}$		7	10	
		$I_O = 1\text{ mA}$ $T_J = -40\text{ to }125^\circ\text{C}$			15	
		$I_O = 25\text{ mA}$		70	100	
		$I_O = 25\text{ mA}$ $T_J = -40\text{ to }125^\circ\text{C}$			150	
		$I_O = 100\text{ mA}$		180	250	
		$I_O = 100\text{ mA}$ $T_J = -40\text{ to }125^\circ\text{C}$			375	
I_{SC}	Short Circuit Current	$R_L = 0$		150		mA
SVR	Supply Voltage Rejection	$C_O = 10\mu\text{F}$ $f = 1\text{ KHz}$		63		dB
V_{INH}	Inhibit Input Logic Low	LOW = Output OFF $T_J = -40\text{ to }125^\circ\text{C}$			0.18	V
V_{INL}	Inhibit Input Logic High	HIGH = Output ON $T_J = -40\text{ to }125^\circ\text{C}$	1.6			V
I_{INH}	Inhibit Input Current	$V_{INH} = 0\text{ V}$ $T_J = -40\text{ to }125^\circ\text{C}$		0	-1	μA
		$V_{INH} = 5\text{ V}$ $T_J = -40\text{ to }125^\circ\text{C}$		5	15	
e_N	Output Noise Voltage	$B_W = 300\text{ Hz to }50\text{ KHz}$ $C_O = 10\mu\text{F}$		160		μV_{RMS}
T_{SHDN}	Thermal Shutdown			170		$^\circ\text{C}$

(NOTE 1): For $V_O < 2.5\text{ V}$ dropout voltage can be calculated according to the minimum input voltage in full temperature range.

LD2981 SERIES

TYPICAL PERFORMANCE CHARACTERISTICS ($T_j = 25^\circ\text{C}$, $V_I = V_{O(\text{NOM})} + 1\text{V}$, $C_I = 1\mu\text{F}(\text{X7R})$, $C_O = 2.2\mu\text{F}(\text{X7R})$, $V_{\text{INH}} = 2\text{V}$, unless otherwise specified)

Figure 1 : Output Voltage vs Temperature

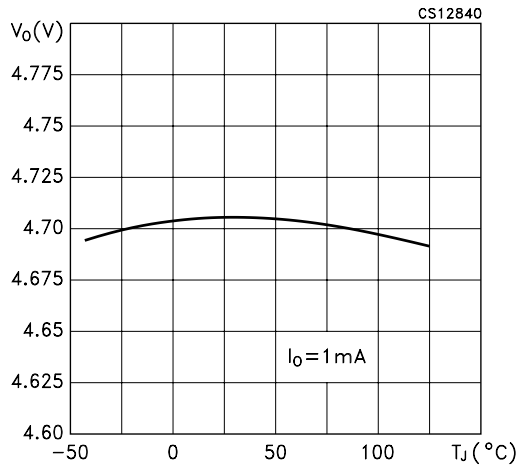

Figure 4 : Load Regulation vs Temperature

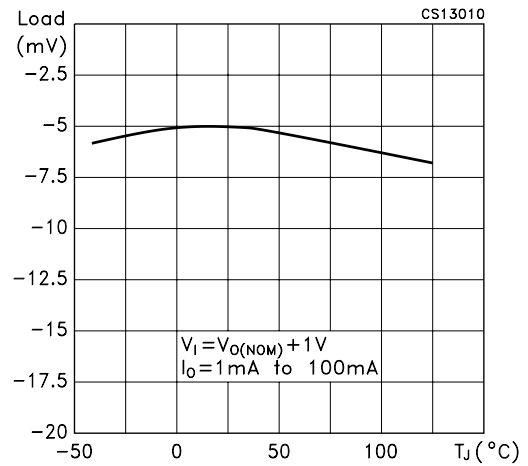

Figure 2 : Output Voltage vs Temperature

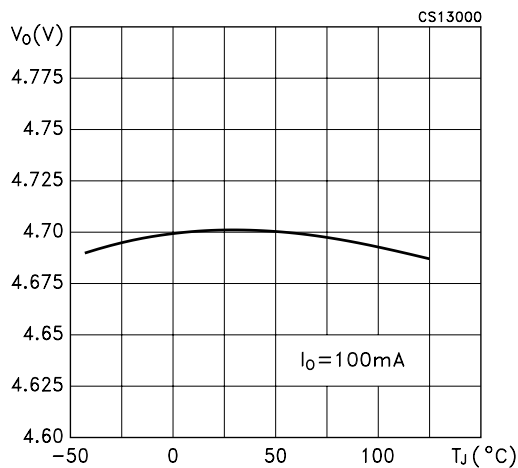

Figure 5 : Dropout Voltage vs Temperature

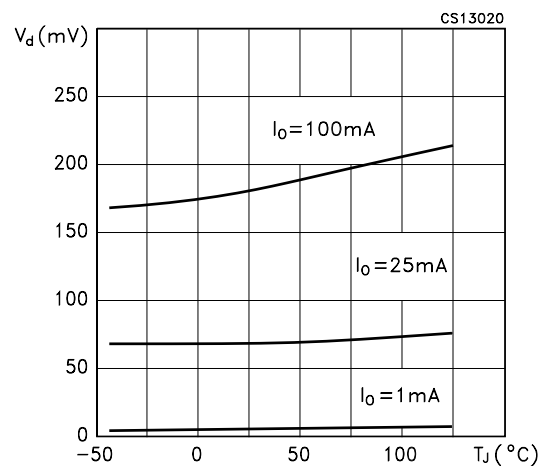

Figure 3 : Line Regulation vs Temperature

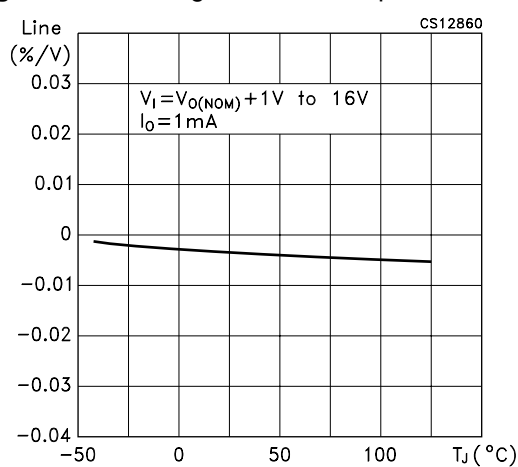

Figure 6 : Quiescent Current vs Temperature

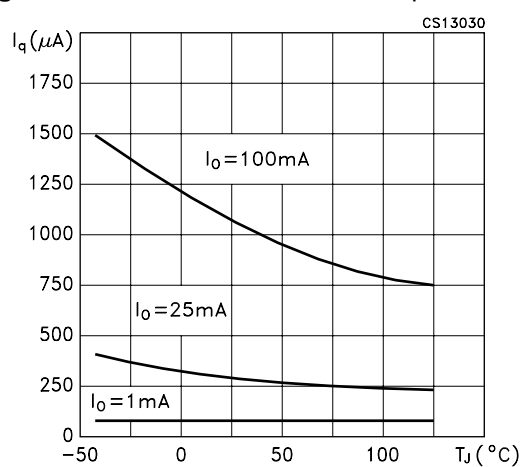

Figure 7 : Quiescent Current vs Output Current

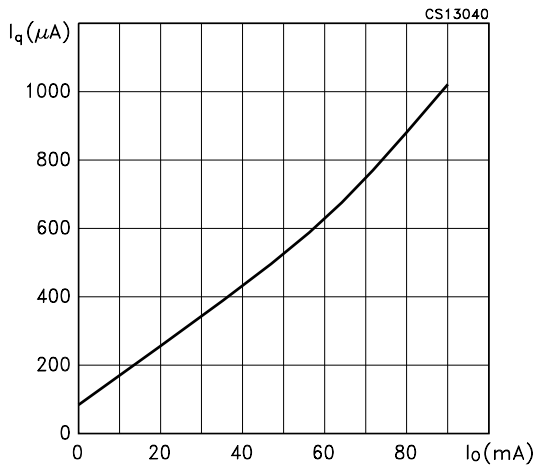

Figure 10 : Dropout Voltage vs Output Current

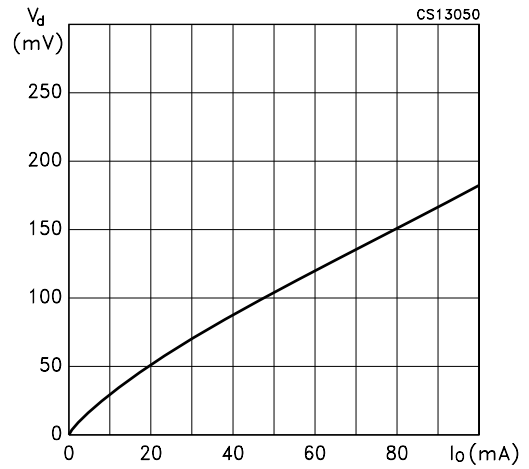

Figure 8 : OFF MODE Quiescent Current vs Temperature

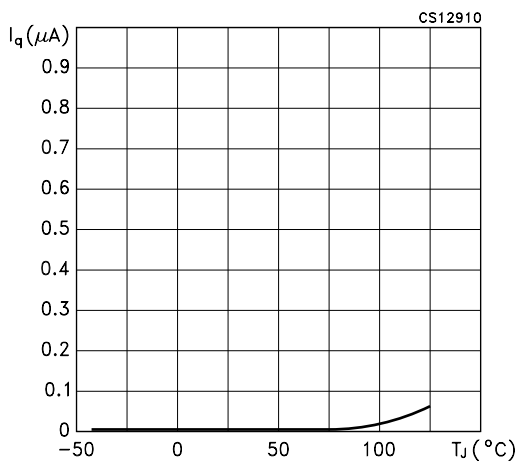

Figure 11 : Inhibit Input Current vs Temperature

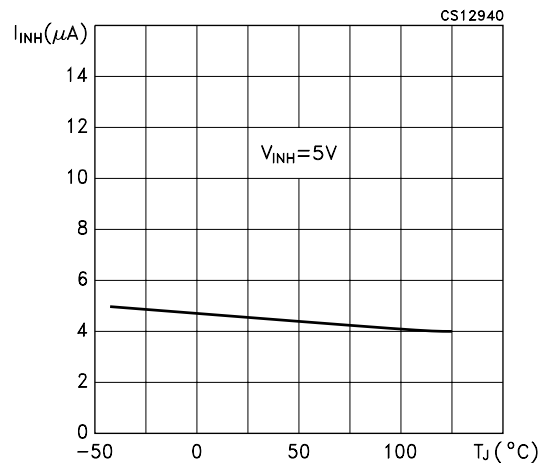

Figure 9 : Quiescent Current vs Input Voltage

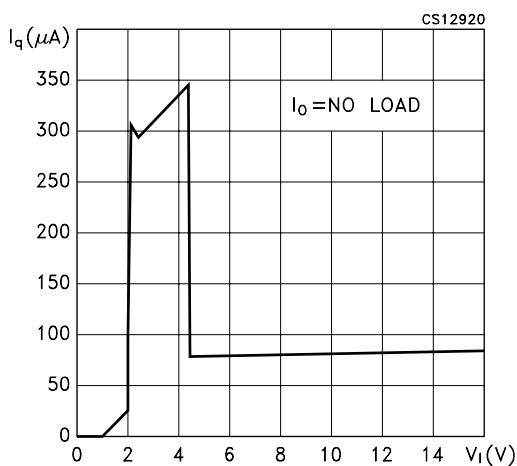

Figure 12 : Inhibit Voltage vs Temperature

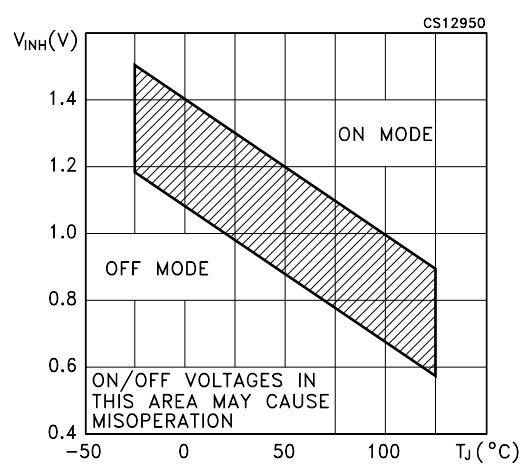

Figure 13 : Supply Voltage Rejection vs Frequency

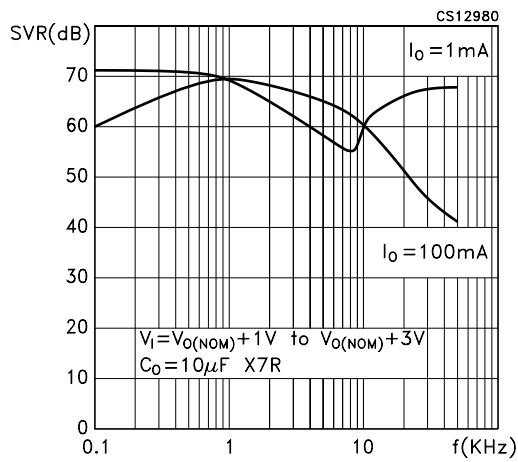

Figure 14 : Noise Voltage vs Frequency

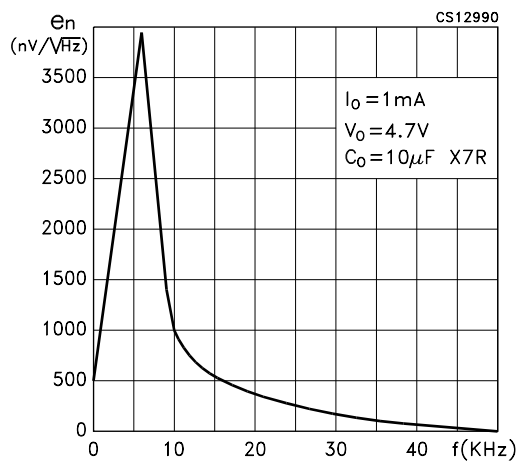

Figure 15 : Best Case: Highest Output Version

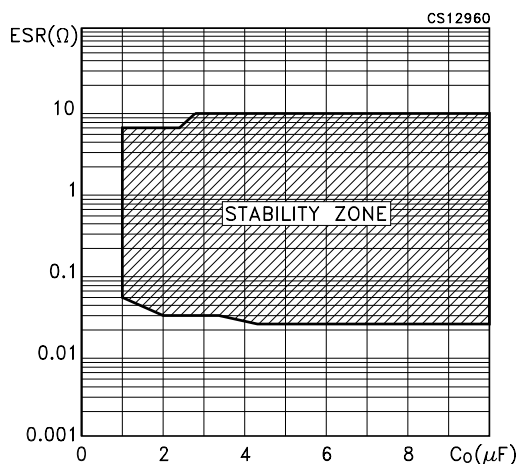

Figure 16 : Worst Case: Lowest Output Version

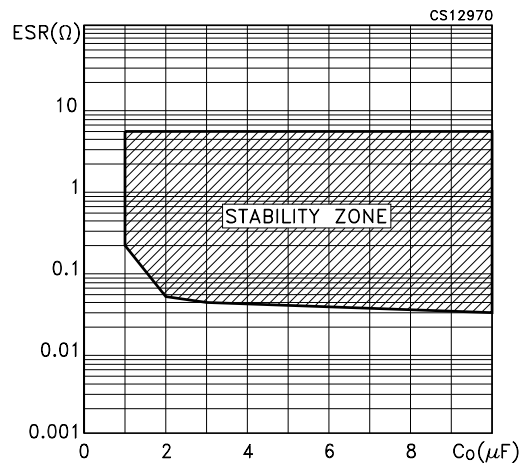

Figure 17 : Load Transient Response

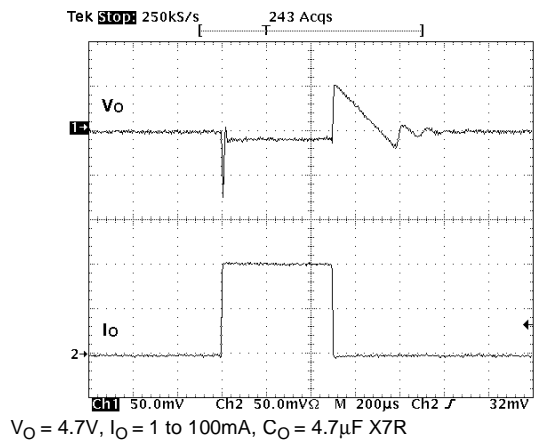
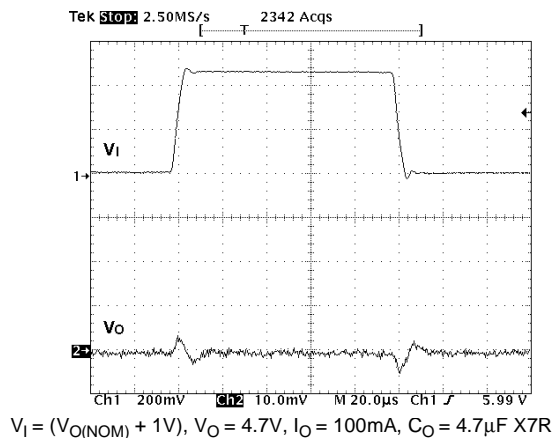

Figure 18 : Line Transient Response



APPLICATION NOTES

EXTERNAL CAPACITORS

Like any low-dropout regulator, the LD2981 requires external capacitors for regulator stability. This capacitor must be selected to meet the requirements of minimum capacitance and equivalent series resistance. We suggest to solder input and output capacitors as close as possible to the relative pins.

INPUT CAPACITOR

An input capacitor whose value is $1\mu\text{F}$ is required with the LD2981 (amount of capacitance can be increased without limit). This capacitor must be located a distance of not more than 0.5" from the input pin of the device and returned to a clean analog ground. Any good quality ceramic, tantalum or film capacitors can be used for this capacitor.

OUTPUT CAPACITOR

The LD2981 is designed specifically to work with ceramic output capacitors. It may also be possible to use Tantalum capacitors, but these are not as attractive for reasons of size and cost. By the way, the output capacitor must meet both the requirement for minimum amount of capacitance and ESR (equivalent series resistance) value. The figures 1 and 2 show the allowable ESR range as a function of the output capacitance. These curves represent the stability region over the full temperature and I_O range. Due to the different loop gain, the stability improves for higher output versions and so the suggested minimum output capacitor value, if low ESR ceramic type is used, is $1\mu\text{F}$ for output voltages equal or major than 3.8V, $2.2\mu\text{F}$ for output voltages from 2.85 to 3.3V, and $3.3\mu\text{F}$ for the other versions. However, if an output capacitor lower than the suggested one is used, it's possible to make stable the regulator adding a resistor in series to the capacitor (see Figure1 & Figure2 to choose the right value according to the used version and keeping in account that the ESR of ceramic capacitors has been measured @ 100KHz).

IMPORTANT

The output capacitor must maintain its ESR in the stable region over the full operating temperature to assure stability. Also, capacitor tolerance and variation with temperature must be considered to assure the minimum amount of capacitance is provided at all times. This capacitor should be located not more than 0.5" from the output pin of the device and returned to a clean analog ground.

INHIBIT INPUT OPERATION

The inhibit pin can be used to turn OFF the regulator when pulled low, so drastically reducing the current consumption down to less than $1\mu\text{A}$. When the inhibit feature is not used, this pin must be tied to V_I to keep the regulator output ON at all times. To assure proper operation, the signal source used to drive the inhibit pin must be able to swing above and below the specified thresholds listed in the electrical characteristics section under V_{IH} V_{IL} . Any slew rate can be used to drive the inhibit.

REVERSE CURRENT

The power transistor used in the LD2981 has not an inherent diode connected between the regulator input and output. If the output is forced above the input, no current will flow from the output to the input across the series pass transistor. When a V_{REV} voltage is applied on the output, the reverse current measured, according to the test circuit in figure 19, flows to the GND across the two feedback resistors. This current typical value is $160\mu\text{A}$. R_1 and R_2 resistors are implanted type; typical values are, respectively, $42.6\text{ K}\Omega$ and $51.150\text{ K}\Omega$.

Figure 19 : Reverse Current Test Circuit

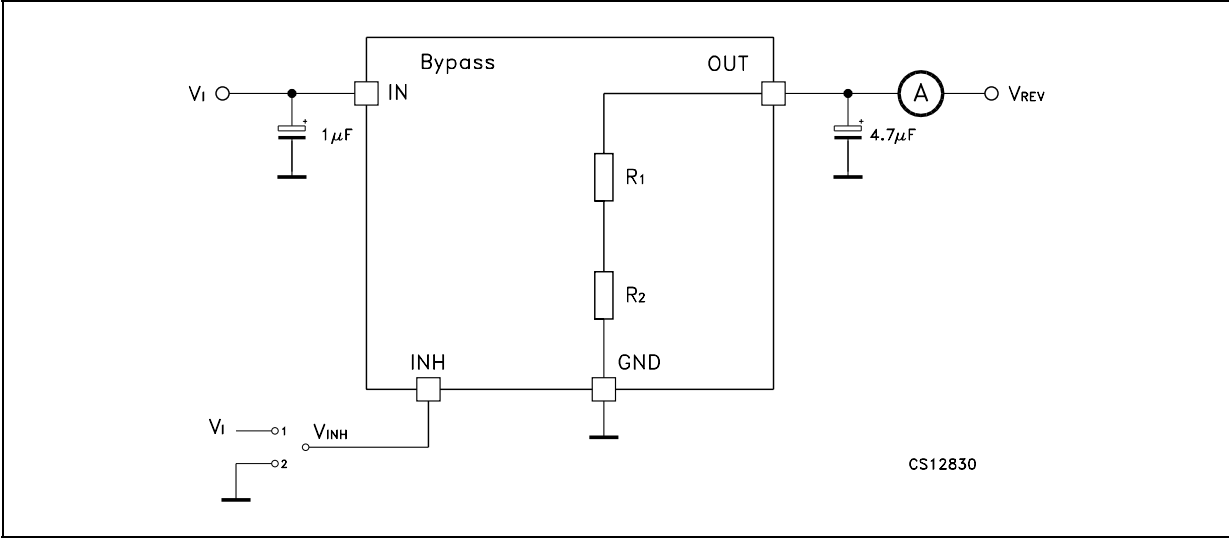

SOT23-5L MECHANICAL DATA

DIM.	mm.			mils		
	MIN.	TYP	MAX.	MIN.	TYP.	MAX.
A	0.90		1.45	35.4		57.1
A1	0.00		0.10	0.0		3.9
A2	0.90		1.30	35.4		51.2
b	0.35		0.50	13.7		19.7
C	0.09		0.20	3.5		7.8
D	2.80		3.00	110.2		118.1
E	1.50		1.75	59.0		68.8
e		0.95			37.4	
H	2.60		3.00	102.3		118.1
L	0.10		0.60	3.9		23.6

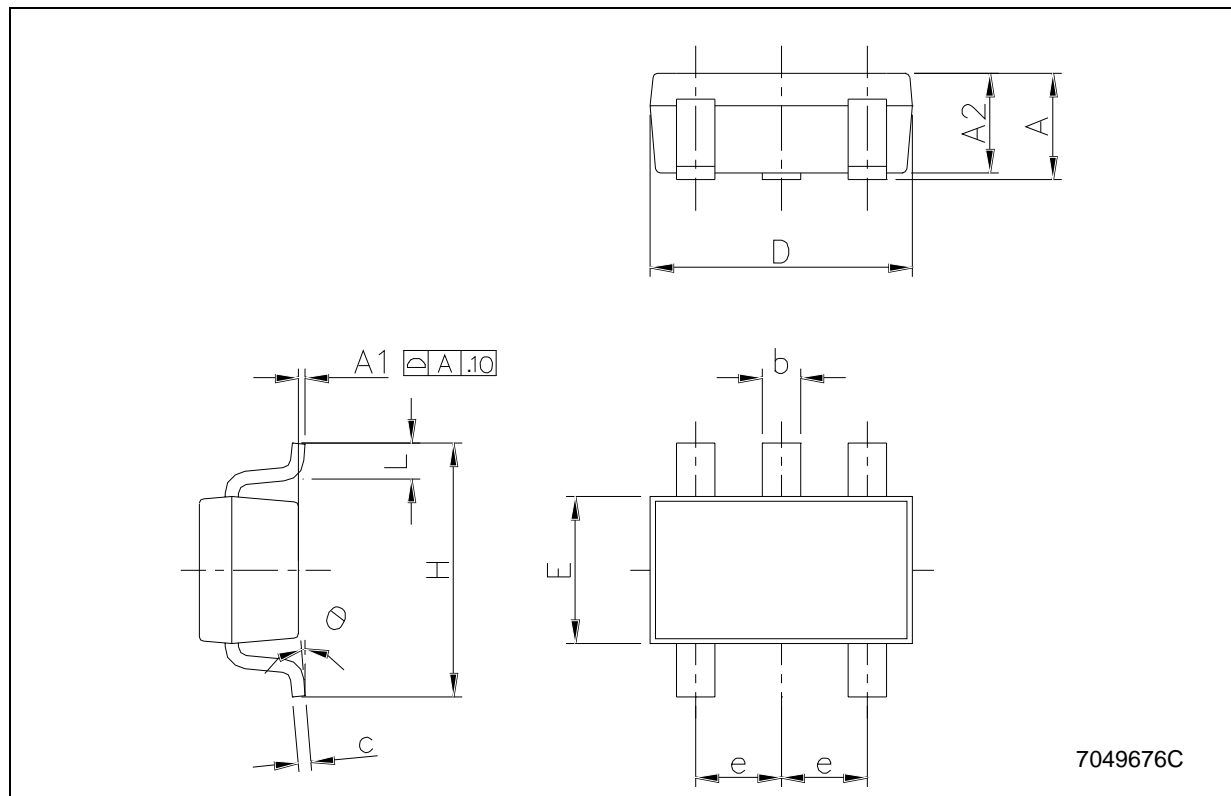

SOT-89 MECHANICAL DATA

DIM.	mm.			mils		
	MIN.	TYP	MAX.	MIN.	TYP.	MAX.
A	1.4		1.6	55.1		63.0
B	0.44		0.56	17.3		22.0
B1	0.36		0.48	14.2		18.9
C	0.35		0.44	13.8		17.3
C1	0.35		0.44	13.8		17.3
D	4.4		4.6	173.2		181.1
D1	1.62		1.83	63.8		72.0
E	2.29		2.6	90.2		102.4
e	1.42		1.57	55.9		61.8
e1	2.92		3.07	115.0		120.9
H	3.94		4.25	155.1		167.3
L	0.89		1.2	35.0		47.2

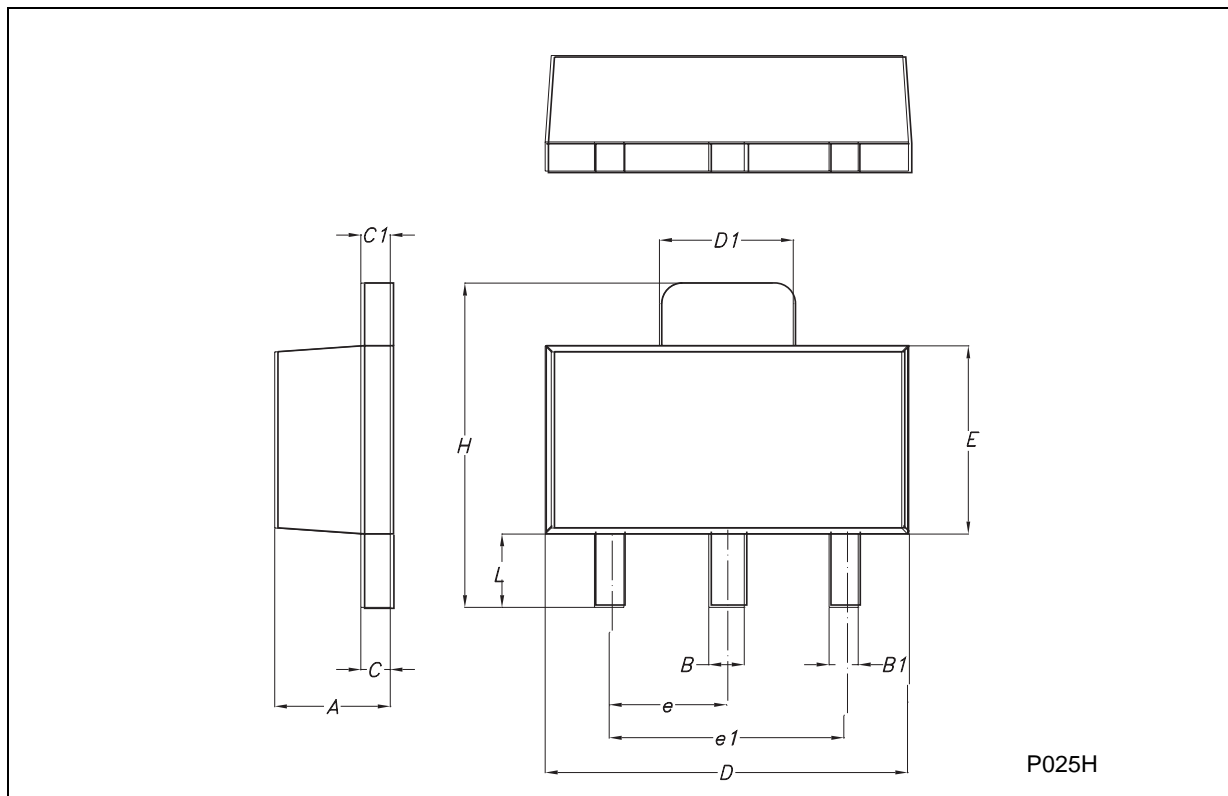

Tape & Reel SOT23-xL MECHANICAL DATA

DIM.	mm.			inch		
	MIN.	TYP	MAX.	MIN.	TYP.	MAX.
A			180			7.086
C	12.8	13.0	13.2	0.504	0.512	0.519
D	20.2			0.795		
N	60			2.362		
T			14.4			0.567
Ao	3.13	3.23	3.33	0.123	0.127	0.131
Bo	3.07	3.17	3.27	0.120	0.124	0.128
Ko	1.27	1.37	1.47	0.050	0.054	0.058
Po	3.9	4.0	4.1	0.153	0.157	0.161
P	3.9	4.0	4.1	0.153	0.157	0.161

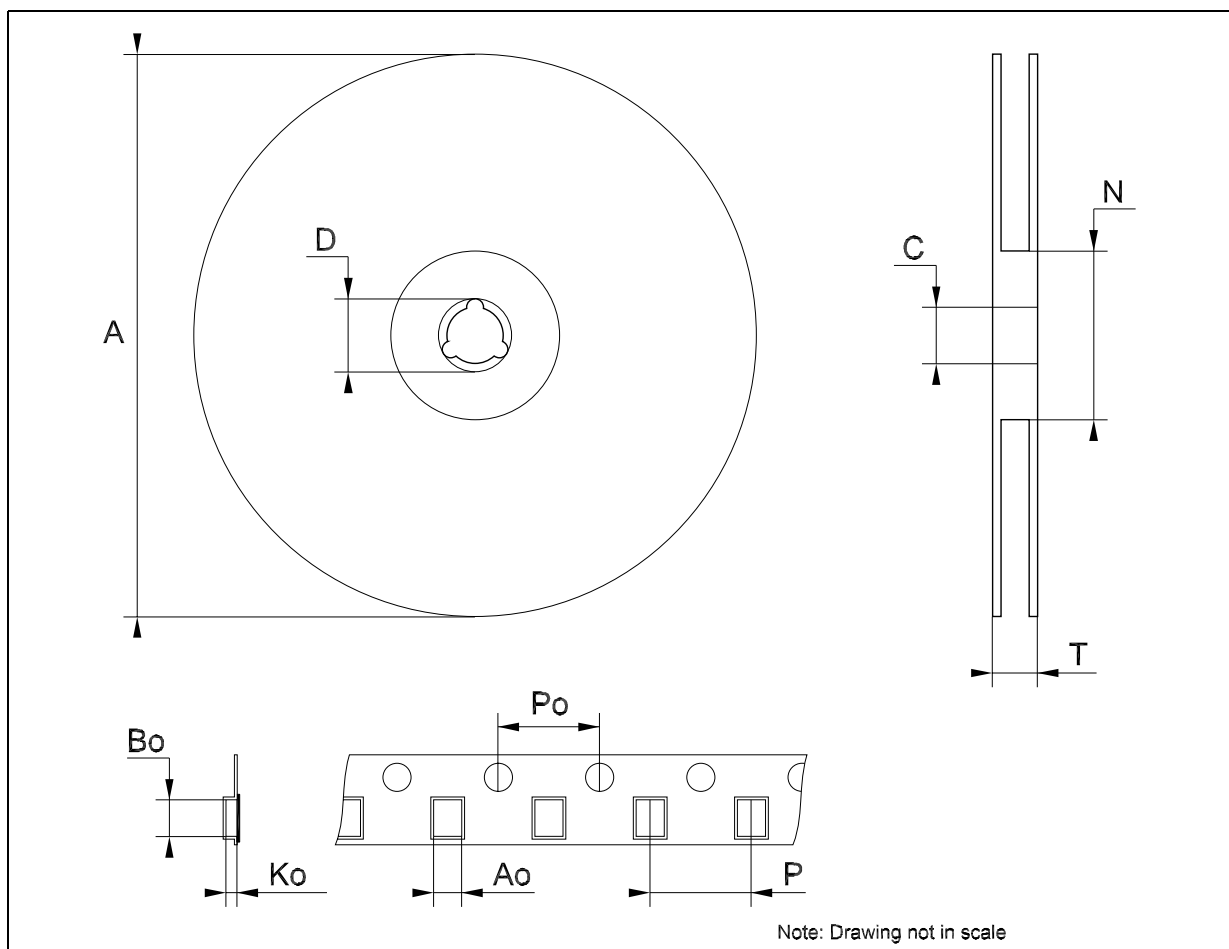

Tape & Reel SOT89 MECHANICAL DATA

DIM.	mm.			inch		
	MIN.	TYP	MAX.	MIN.	TYP.	MAX.
A			180			7.086
C	12.8	13.0	13.2	0.504	0.512	0.519
D	20.2			0.795		
N	60			2.362		
T			14.4			0.567
Ao	4.70	4.80	4.90	0.185	0.189	0.193
Bo	4.30	4.40	4.50	0.169	0.173	0.177
Ko	1.70	1.80	1.90	0.067	0.071	0.075
Po	3.9	4.0	4.1	0.153	0.157	0.161
P	7.9	8.0	8.1	0.311	0.315	0.319

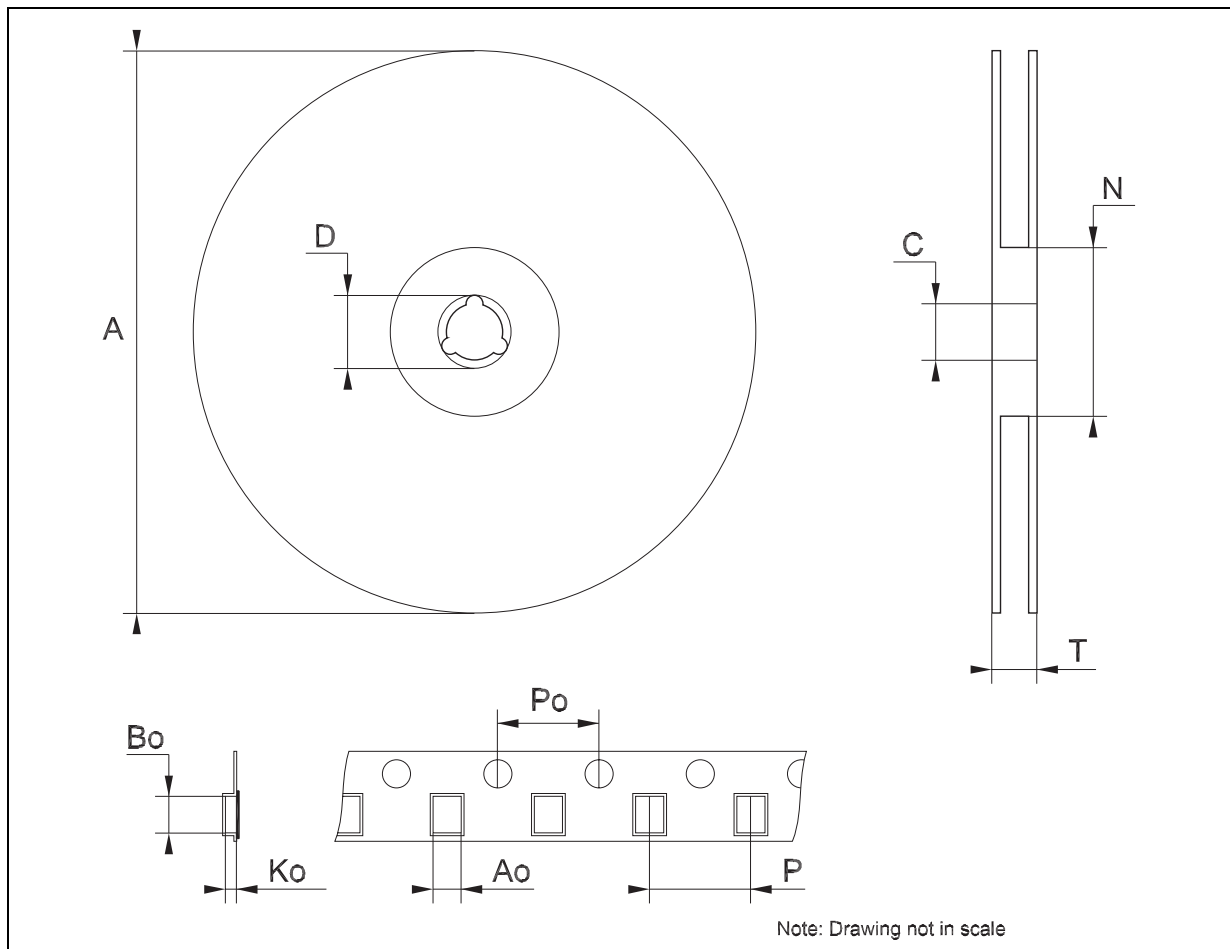

Information furnished is believed to be accurate and reliable. However, STMicroelectronics assumes no responsibility for the consequences of use of such information nor for any infringement of patents or other rights of third parties which may result from its use. No license is granted by implication or otherwise under any patent or patent rights of STMicroelectronics. Specifications mentioned in this publication are subject to change without notice. This publication supersedes and replaces all information previously supplied. STMicroelectronics products are not authorized for use as critical components in life support devices or systems without express written approval of STMicroelectronics.

The ST logo is a registered trademark of STMicroelectronics
All other names are the property of their respective owners

© 2003 STMicroelectronics - All Rights Reserved
STMicroelectronics GROUP OF COMPANIES

Australia - Belgium - Brazil - Canada - China - Czech Republic - Finland - France - Germany - Hong Kong - India - Israel - Italy - Japan -
Malaysia - Malta - Morocco - Singapore - Spain - Sweden - Switzerland - United Kingdom - United States.

<http://www.st.com>